



## LEADING THE CLEAN AIR REVOLUTION

The expertly designed UV-FLOW series delivers a **perfect balance of efficacy and safety** making it one of the **most energy efficient** sources eACH on the market.

When **sustainability**, improved **indoor air quality**, and **low maintenance costs** matter, consider the UV-FLOW. It is offered in different power levels each allowing a **tailored fit** to any size environment.

We deploy an industry leading **commissioning** and **validation** process to be assured customers are receiving exactly what is needed at each installation. Once installed, the UV-FLOW can operate silently and continuously 24/7 in **populated environments**.

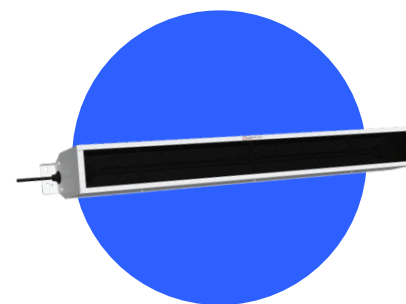

## KEY PRODUCT FEATURES

- **Take it To The People**, designed for a wide variety of environments including healthcare facilities, schools, offices, and other shared spaces.
- **Increased Disinfection Performance** with High-Output UV-C lamps (253,7 nm) and parabolic mirror-bright aluminum reflector, this is the ultimate design for the most demanding performance and safety requirements.
- **UV-C Where You Need**, proprietary honeycomb grid redirects UV rays into a unidirectional flow, creating a "UV beam" that cleans the air above people occupying a space.
- **Safety Comes First** with visible indicator on the power switch and an automatic shut-off when the cover is opened.
- **Built to Last**, designed and constructed from the ground up with high-quality coated aluminum and durable UV-resistant materials.
- **Leave It On**, when properly installed, the device can deliver persistent disinfection 24/7 for up to 18,000 before replacing the Light Progress UVC Lamps. Replace lamps without disinstall the unit.

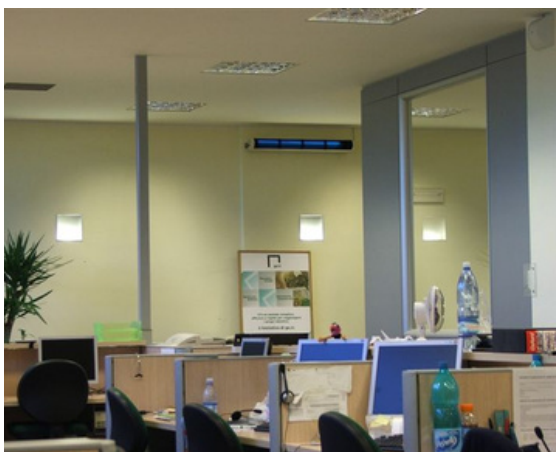

HEALTHCARE



HVAC



PROCESS  
INDUSTRY



HOSPITALITY



SHARED  
SPACES



PUBLIC  
VENUES



WELLNESS  
CENTRES



TRANSPORT

## TECHNICAL TABLE

<b>UV-FLOW-90H-C-WH</b>	
REPLACEMENT LAMP	n°1 CHS-90WHF
POWER CONSUMPTION	90W
DIMENSION (WxHxD)	mm 986 x 109 x 151 (in 38.81 x 4.29 x 5.94)
WEIGHT	kg 5 (lb 11.02)
AREA COVERAGE (> 10µW/cm²)	m² 16 (ft² 172.22)
<b>FOR ALL MODELS</b>	
LAMP LIFE (hours)*	≤ 18.000
PROTECTION RATING	IP20
OP. TEMPERATURE**	MIN. -15°C ÷ MAX. +40°C   (MIN. 5.0°F ÷ MAX. +104.0°F)
OP. RELATIVE HUMIDITY**	From 20 to max. 90%
VAC   FREQUENCY	230V or 110-277V   50/60 Hz
POWER SUPPLY	On-board power supply always included.
ELECTRICAL CONNECTION	Cable 3x1 mm², lenght 2.5 m (ft 8.2)/plug on request

\* Continuous operation

\*\* Outside of these ranges, performance may not be optimal

## PLANNING THE INSTALLATION

		<b>UV-FLOW-90H-C-WH</b>
<b>1. MINIMUM ROOM SIZE</b>	MINIMUM HEIGHT FROM THE FLOOR TO THE CEILING	m 3,00 (ft 9.8)
	MINIMUM LENGHT OF LONG SIDE (B) (distance from the wall opposite the device)	m 3,50 (ft 11.48)
	MINIMUM LENGHT OF SHORT SIDE (A) (the wall were the device is installed)	m 3 (ft 9.84)
<b>2. POSITIONING THE DEVICE</b>	MINIMUM DISTANCE FROM CEILING TO DEVICE (top side)	cm 30 (ft 0.98)
	MINIMUM DISTANCE FROM FLOOR TO DEVICE (bottom side) (D)	m 2,4 (ft 7.9)
	MINIMUM DISTANCE FROM SIDE WALLS TO DEVICE (center) (C)	TO BE PLACED AT THE CENTER OF THE WALL
<b>UV-C power µW/cm² from the face of the fixture, on the horizontal center-line of the UV beam</b>	at 60 cm (23 in) (0)	63
	at 1 m (3.2 ft) (1)	33
	at 2 m (6.5 ft) (2)	18
	at 3 m (9.8 ft) (3)	11,6
	at 4 m (13 ft) (4)	6,56

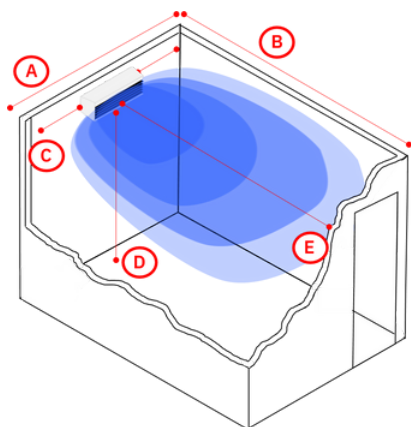

**ROOM REFERENCE SIZES FOR A CORRECT APPLICATION**

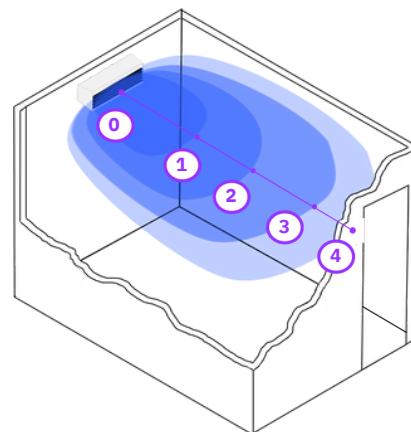

**UV-C POWER MEASURED ON THE HORIZONTAL CENTER LINE**

## UPPER ROOM GUV APPLICATION

**UPPER-AIR** devices utilize **natural or mechanical air currents** that circulate airborne infectious agents to the upper layers of rooms. Once in the upper layers, they are exposed to UV-C radiation, **which eliminates them.**

Upper room GUV air disinfection with good air mixing **has been shown under real-life conditions to produce the equivalent of adding as much as 24 room air changes per hour**—quietly, safely and sustainably.

These units are mounted on the wall at a height above 2,30 mt or 7.5 ft. They use **non-reflective louvres** to **direct UV-C energy upward and outward**, ensuring that UV emissions do not enter the part of the room that is occupied.

**Upper-room UVGI has been used for over 70 years, under high-risk conditions, and especially where few buildings have efficient mechanical ventilation systems, the only practical approach to the environmental control of airborne infection is upper room GUV.**

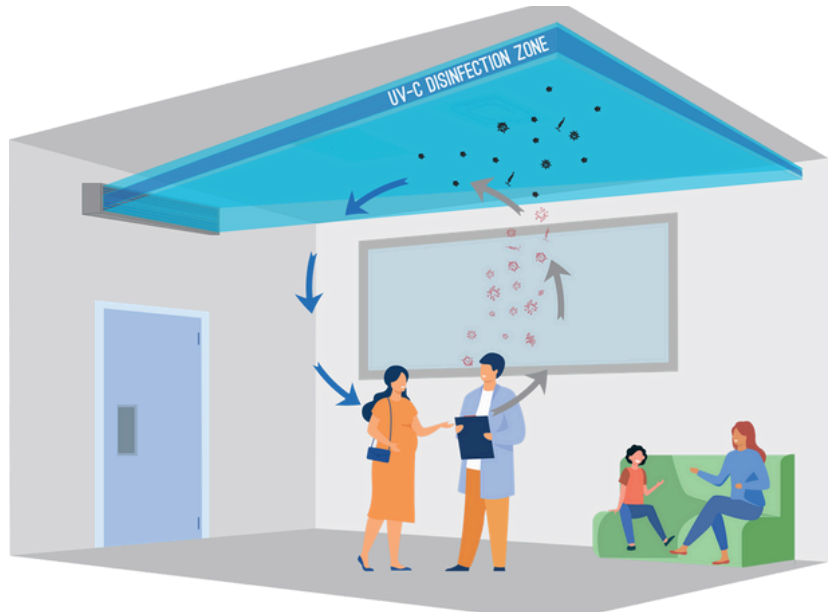

ASHRAE's Mission and Vision To serve humanity by advancing the arts and sciences of heating, ventilation, air conditioning, refrigeration and their allied fields creating standards for healthy and sustainable built environment for all.

*ASHRAE defines the application of UPPER AIR systems to fight airborne infectious diseases as the **highest priority***



DOE is measuring the cost savings provided by GUV technology as an energy-efficient approach to improve indoor air quality, reduce transmission of diseases in buildings, and prepare for future epidemics or pandemics.

*"Germicidal ultraviolet is a method of air and surface disinfection that may provide effective reduction of virus transmission in buildings **without the need for energy-intensive high-ventilation solutions.** (...)*



## TAILORED TO EVERY ENVIRONMENT:

### Measure | Design

After measuring the exact dimensions and assessing obstacles or reflective surfaces in a target installation, we **calculate a solution for the optimal number, form factor, and output energy** of UV-FLOW devices.



## Energy cost per eACH of various strategies

**GUV has much lower energy cost** than 100% outside air for **equivalent disinfection.** Energy cost savings and decarbonization benefits vary by location, as shown on the table below\*:

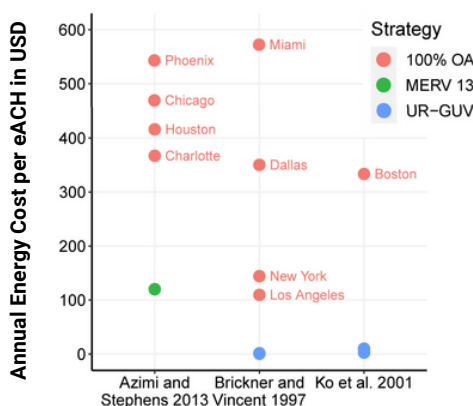

**Upper room UVGI is far less expensive** per year per equivalent air changes per hour (ACH) **compared to mechanical ventilation or other commercial air cleaners\***.

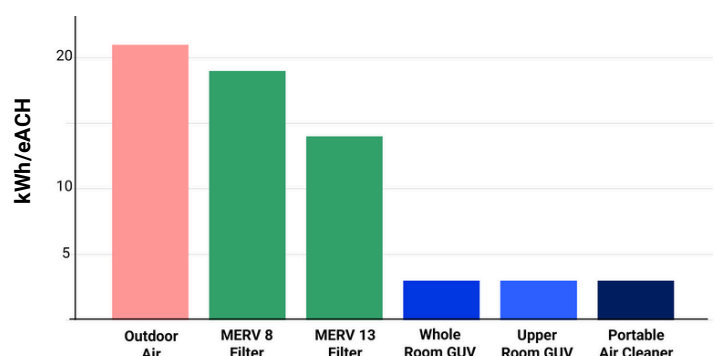

\*Source: Pacific Northwest National Laboratory

## SAFE GUV DESIGN

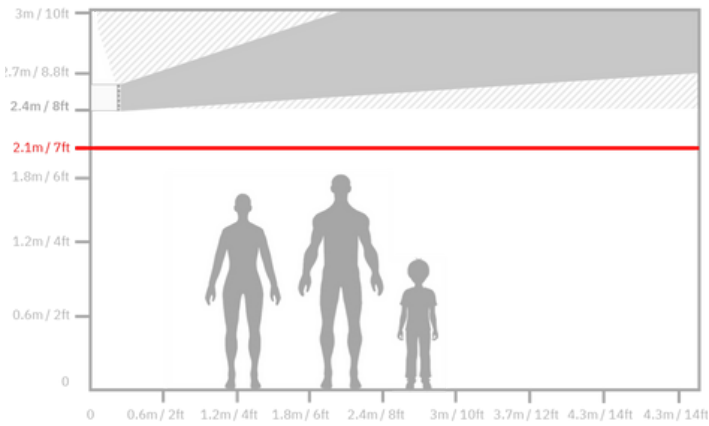

If designed and installed according to the user manual, **UV-FLOW series allow you to comply with the most widely accepted safety guidelines:**

- **Threshold Limit Value (TLV) of 6 mJ/cm<sup>2</sup> over an eight-hour period** (according to ACGIH committee on Physical Agents for UV-C 254nm exposure);
- **Limit of irradiance [0.2 μW/cm<sup>2</sup>] at 7 ft (2,10m) from the floor** in any part of the room.

**All guidances** on the design, installation, testing, and safe operation of upper-room UVGI systems is **based on science and practice-based evidence.**

## TROUBLE-FREE INTEGRATION AND INSTALLATION



- We provide the optimal point of integration for every product
- Mounting and powering the device can be done without complex requirements.
- Ongoing maintenance only takes a few minutes to replace lamps when necessary.

## SOFTWARE ENGINEERED DISINFECTION

From our in-depth know-how on the subject and with our proprietary dosage calculation software we can simulate device performance and validate effectiveness in every application.

Calculation Software

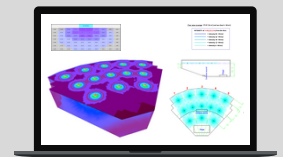

## TECHNICAL DRAWINGS

Every Light Progress Product is available in detailed DWG and STEP files for your design-in and specification clarity.

VIEW or DOWNLOAD now



## POST-INSTALLATION

7'-16"	4'-16"	0'-16"	4'-16"	7'-5"-16"
n.d. μW/cm <sup>2</sup>	n.d. μW/cm <sup>2</sup>	0.0026 μW/cm <sup>2</sup>	n.d. μW/cm <sup>2</sup>	n.d. μW/cm <sup>2</sup>
7'-2"-5"	4'-5"	0'-5"	4'-5"	7'-6"-5"
n.d. μW/cm <sup>2</sup>	0.0023 μW/cm <sup>2</sup>	0.0136 μW/cm <sup>2</sup>	n.d. μW/cm <sup>2</sup>	n.d. μW/cm <sup>2</sup>
7'-4"-9"	4'-9"	0'-9"	4'-9"	7'-9"-9"
0.0024 μW/cm <sup>2</sup>	0.0055 μW/cm <sup>2</sup>	0.0083 μW/cm <sup>2</sup>	0.0065 μW/cm <sup>2</sup>	n.d. μW/cm <sup>2</sup>
7'-6"-13"	4'-13"	0'-13"	4'-13"	8'-13"
0.0048 μW/cm <sup>2</sup>	0.0064 μW/cm <sup>2</sup>	0.0181 μW/cm <sup>2</sup>	0.0082 μW/cm <sup>2</sup>	0.0038 μW/cm <sup>2</sup>
7'-8"-16"	4'-16"	0'-16"	4'-16"	7'-8"-16"
0.0076 μW/cm <sup>2</sup>	0.0134 μW/cm <sup>2</sup>	0.0318 μW/cm <sup>2</sup>	0.0144 μW/cm <sup>2</sup>	0.0061 μW/cm <sup>2</sup>



Our customers rely on our knowledge and support for the post-installation phase:

**Validation** is completed by measuring the GUv throughout the installation with photobiological testing standard;

This verifies every **Installation** has been applied to manufacturer instructions and is performing as advertised to safely and effectively improve indoor air quality;

Finally, installation is ready to be **Operated** by a trained and supported customer.

**Light Progress Group SRL**  
Anghiari (AR)  
ITALIA  
P: (+39) 0575 749255  
E: info@lightprogress.it  
W: www.lightprogress.it

**Light Progress GmbH**  
Aschaffenburg (BY)  
DEUTSCHLAND  
P: +49 176 761 42327  
E: gmbh@lightprogress.de  
W: www.lightprogress.de

**Light Progress LLC**  
Dallas, (TX)  
USA  
P: (+1) 833-882-4255  
E: americas@lightprogress.it  
W: www.lightprogress.us

**OFFICIALLY DISTRIBUTED BY:**